

Process Pumps and Equipment for Biofuels Applications





Reliable Sulzer Technology for a More Sustainable World

Sulzer is the trusted market leader in pumps for ethanol plants across North America and a major player in pumping and mixing applications in European plants. Advanced biofuels, from non-food sources, show great potential as a renewable transportation fuel and place new demands on biorefinery processes. Sulzer has pumping and mixing technologies in operation at many advanced biofuels facilities, and we support our customers with the development of environment-friendly technologies for pilot, demonstration and commercial installations. Our extensive experience and know-how in pulp and paper, oil and gas, and hydrocarbon processing industries ensure that Sulzer's process equipment and pumps operate efficiently and reliably in advanced biorefinery processes and a wide range of biofuels applications.

Reliability

The reliability of your pumping and mixing solution mainly depends on the the right selection, proper product design, precise manufacturing, timely delivery process, efficient aftermarket service and all associated support.

With latest manufacturing technology and strict quality control procedures, Sulzer assures high levels of efficiency and performance over a full range of process conditions. At Sulzer all our pumps are tested before delivery. The wide references from Pulp and Paper Industry (PPI), biofuels and general industry operation around the whole world confirm our proven reliability. Together, all these factors mean high pumping and mixing performance and create high lifecycle value for our customers.

Research

Research and development are top priority at Sulzer. The world's largest R&D center specialized in PPI and biofuels pumping and mixing is located in Kotka, Finland. We work closely with our customers to develop pumps and mixers that suit our customers' processes in the best possible way. At our full scale testing facilities, all process equipment can

be tested under operating conditions controlled to closely match customer operations. We are also able to make pumping and mixing test runs based on customers' own furnish.

We apply our own foundry expertise and deep metallurgical knowledge to developing equipment for applications requiring strong resistance to corrosion and wear.

Presence

Our focused sales and service people bring their extensive knowledge to every customer relationship. Their work—and yours—is complemented by our global knowledge support and excellent sales documentation. Local tendering and order handling ensures quick response to all your pumping and mixing needs.

In addition to our PPI and biofuels industry dedicated personnel and competencies, customers benefit from access to the entire Sulzer organization, including 60 service centers around the world.



Sulzer Innovations for Pulp and Paper and Biofuels

The R&D work at Sulzer has resulted in many pump, mixer and agitator innovations for different target industries. Over the decades, this continuous search for better pumping and mixing solutions has lengthened service intervals and prolonged pump life times in various applications. We are the forerunner in stock pumping and mixing over the whole consistency range from 0 to 18%.

1980	Medium consistency MC® pumping technology	2000	– MCE™, the 3 rd generation MC® pumping system
1987	AHLSTAR™ stock/process pump, AHLMIX™ chemical mixer, MC® flow discharger	2001	products
1988	– MCA, MCV; the 2 nd generation MC® pumping	2004	The Fluidier™ stock pumping concept
1990	Systems with external and internal degassing	2005	New AHLSTAR series process pumps
1991	ZPP low-pulse headbox feed pump	2006	MBN multistage ring section pump
1992	SALOMIX® SL side entry agitator family	2009	SX Chemical mixer
1993	AHLMIX™, the 2 nd generation chemical and steam mixer	2009	New product sizes and higher capacities for AHLSTAR, MCE, KCE and MBN pumps
1995	AHLSTAR™ ASP self-priming gas removal pump	2011	New, large-size, high-efficiency AHLSTAR series process pumps
1996	AHLMIX™ FS, gas mixing concept	2012	AHLSTAR process pumps integration
1999	SALOMIX® TES top entry spreader	2013	AHLSTAR close coupled process pumps
2000	SALOMIX® GLI bottom zone mixing and dilution arrangement		

Key Success Factors for Sulzer's Continuous Development

- Intensive R&D with full-scale testing facilities
- Test center focusing on biomass treatment and handling
- Vast experience to handle different liquids and their applications
- Agitation research of different feed stocks in full scale
- Demonstration runs and trials for customers
- Partnership programs to improve customer processes



Sulzer Core Technologies, Products and Services

Sulzer's pumps and mixers are famous for their innovative and sturdy design. We make standardized products for all normal applications and specialty products for applications with special requirements.

Technologies	<ul style="list-style-type: none"> • Centrifugal pumping and mixing with superior hydraulics and design • Vast knowledge of corrosion and wear-resistant materials • Agitation of large volumes and in-line mixing of suspensions • Flow management of towers, tanks, gas separation and mixing • Solutions for high-pressure and low-pH operating conditions
Products and Services	<ul style="list-style-type: none"> • Centrifugal pumps for clean liquids, chips, medium slurry, high solids and grassy materials pumping • Gas removal pumps and gas mixers, mixers for various suspensions, deflaking pumps to break up bundles and particles • Feed systems, agitation, dilution and discharge for tanks and towers • Testing for customers, application and flow behavior studies

CPT ANSI Process Pump Gains Its Advantage from Inside-Out

The real difference between the CPT and other ANSI pumps is what you'll find inside: Heavy-duty bearing unit and wet-end materials. Outside, the CPT offers special features that simplify maintenance and adjustment.

CPT Process Pump

The CPT chemical process pump is designed for continuous operation in process industries for pumping, clean, abrasive or corrosive liquids. The pump is designed to exceed ANSI (ASME B73.1M) pump standards.

Capacities up to 1,600 m³/h / 7,040 USgpm

Heads up to 220 m / 720 ft

Pressures up to 26 bar / 375 psi

Temperatures 260 °C / 500 °F

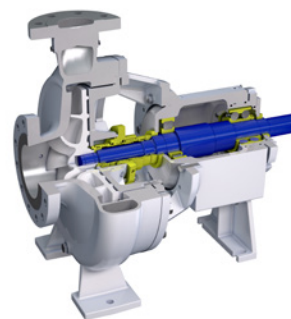



AHLSTAR

The Answer to Your Process Needs

Designed especially for the pulp and paper and general industry, every AHLSTAR pump is tailor-made to ensure process reliability, high efficiency and low operating costs. AHLSTAR pumps save energy, sealing water and environment. Designed to meet the EN ISO 5199 reliability standard, these pumps also comply to EN 22858 (ISO 2858) standard. The modular interchangeability of parts and components enables low spare parts inventory. The pump range offers the lowest total cost shaft seal concept, with dynamic seal, mechanical seals and packing. Every AHLSTAR pump is designed for fast and easy installation, maintenance and service.

AHLSTAR A

For all normal pumping applications, with stocks up to 8%, e.g., liquors, water, chemicals, white water, condensate, etc.

Capacities 11,000 m³/h / 48,400 USgpm

Heads 160 m / 525 ft

Pressures 16 / 25 bar, 230 / 360 psi,
depending on material and size

Temperatures 180 °C / 356 °F

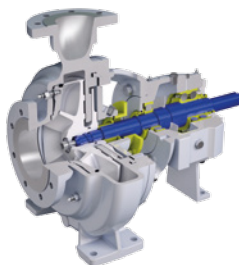

AHLSTAR W

For the most abrasive and erosive pumping applications, such as lime milk and mud, and coating pigments. Specially designed wear-resistant pumping hydraulics (W) with wear-resistant materials deliver six to eight times longer life time than conventional pumps.

Capacities 7,000 m³/h / 30,800 USgpm

Heads 110 m / 360 ft

Pressures 16 / 25 bar, 230 / 360 psi,
depending on material and size

Temperatures 180 °C / 356 °F

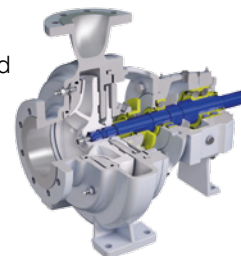

AHLSTAR N

For applications where normal stock pumps cannot handle liquids due to plugging or abrasive wear. Suitable for unsorted stocks up to 8%, e.g., slurries, rejects, waste water, chips, or other liquids containing large solids and other particles.

Capacities 2,000 m³/h / 8,800 USgpm

Heads 90 m / 295 ft

Pressures 16 bar, 230 psi,
depending on material and size

Temperatures 180 °C / 356 °F

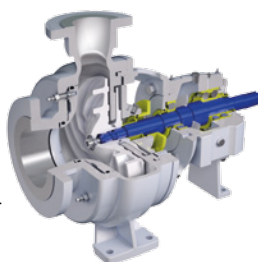

AHLSTAR E

Developed especially for pumping hot liquors such as in continuous and batch digesters (E hydraulics). Centerline supported design prohibits heat and pressure shock distortions.

Capacities 6,100 m³/h / 26,840 USgpm

Heads 160 m / 525 ft

Pressures 25 bar / 360 psi,
depending on material and size

Temperature 210 °C / 410 °F

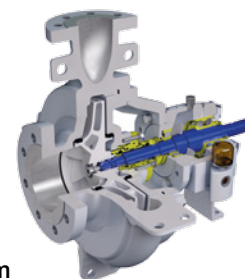



Solving Air and Gas Problems in Your Process

The AHLSTAR range includes the total pumping concept for air and gas containing liquids with stock pumping (A), non-clogging (N) and wear-resistant (W) pumping hydraulics.

These pumps are used for pumping various air or gas containing stocks with consistency up to 8%, e.g., liquors, soap, foaming liquids, slurries, and liquids with a low level in the tank. They are also suited for free air/gas content of up to 40%.

AHLSTAR A, N and W Self-Priming Gas Removal Pumps

- A built-in vacuum pump
- Due to the self-priming capability, the pump can be used in seal pit and floor channel applications instead of vertical or submersible pumps.

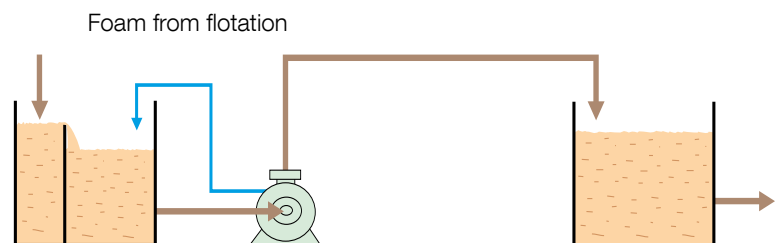
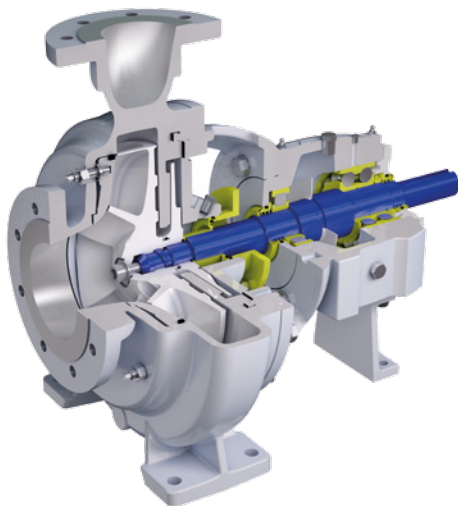

AHLSTAR Gas Removal Pump pumping foam-containing liquid in a flotation line

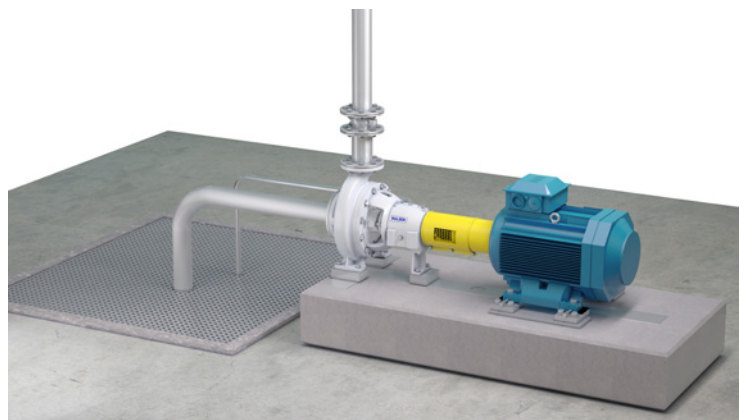



AHLSTAR A, N and W Pumps with Gas Separator

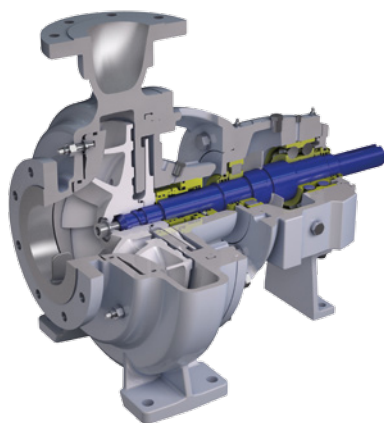

Advantages and Benefits

- A built-in gas separator
- Trouble-free process operation, despite high air content
- Reduces the need for expensive and environmentally-damaging anti-foam agents
- Maintains a stable pumping pressure for smooth production
- Gas/air removal improves the efficiency of other process equipment
- An A, N or W pump can be later converted into an A, N or W self-priming gas removal pump or into a pump with gas separator or vice versa



Pumps for Your Most Critical Applications and Demanding Conditions

The Sulzer product range includes several pump types designed for applications with special requirements in various processes.

ZPP

ZPP headbox feed pumps are designed for high volume flows and especially for today's high-speed paper and board machines requiring minimum pulsation, absolute reliability and high efficiency. Precision castings from our own foundry are a key factor in fulfilling the low pulsation requirements. High-quality surface finishing eliminates fiber hang-up or build-up of deposits. Proven reliability with various paper grades in most world-record paper and board machines.

Capacities up to 30,000 m³/h / 132,000 USgpm

Heads up to 160 m / 525 ft

Pressures up to 25 bar / 362 psi

Temperatures up to 120 °C / 250 °F



MBN

MBN multi stage ring section pump for clean or slightly contaminated liquids in shower water, sealing water, boiler feed water applications, etc., where a high pressure/high head is needed. Features our innovative polygon fit between impellers—no keys needed. Maintenance-free dynamic seal, mechanical seals and gland packing are available for shaft sealing. Easy to maintain, needing only one roller bearing unit and one shaft seal.

Capacities up to 110 l/s / 1,740 USgpm

Heads up to 900 m / 2,950 ft

Pressures up to 100 bar / 1,450 psi

Temperatures up to 180 °C / 355 °F

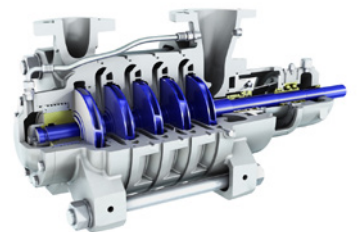

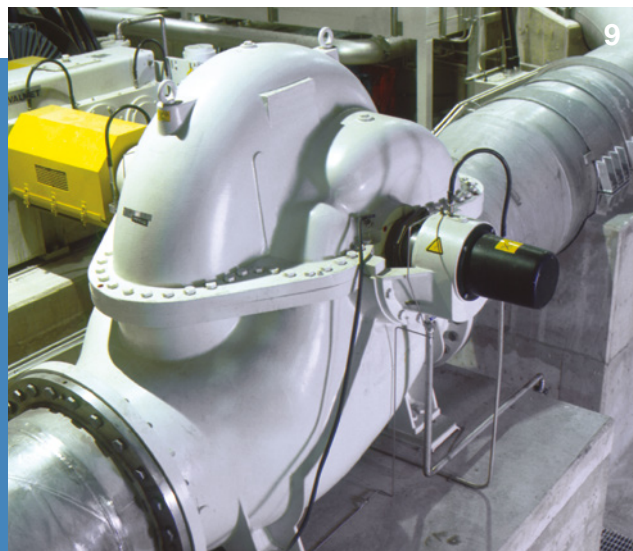

NK, WK

NK/WK non-clogging, cantilever pumps for all types of severe applications in seal pits and floor channels. For waste stock, slurries and waste water containing large solid particles

Capacities 430 m³/h / 1,900 USgpm

Heads 60 m / 200 ft

Pressures 10 bar / 150 psi, depending on material and size

Temperatures 95 °C / 205 °F



NV

NV non-clogging vertical pumps for all types of severe applications in seal pits and floor channels. For waste stock, slurries and waste water containing large solid particles.

Capacities 1,200 m³/h / 5,400 USgpm

Heads 85 m / 280 ft

Pressures 10 bar / 150 psi, depending on material and size

Temperatures 95 °C / 205 °F

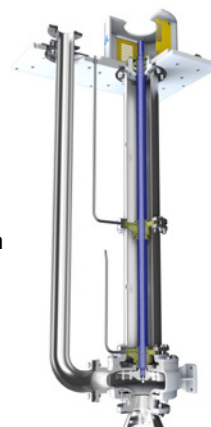

MC/MD

MC/MD high-pressure, multi stage pumps for clean liquids in recovery boiler feed applications. High efficiency and wide hydraulic coverage. Special hydraulics with low NPSHr value provide cavitation-free functioning and low noise level. PERMAVOR® lift off device for extended service life.

Capacities up to 1,000 m³/h / 5,000 USgpm

Heads up to 2,400 m / 8,200 ft

Pressures up to 300 bar / 4,790 psi

Temperatures 210 °C / 410 °F

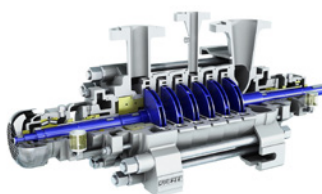

LSP/LST

LSP/LST two-stage, low-speed, high-pressure pumps designed especially for pumping make-up and wash liquor in continuous digester service. A two-stage pump with back pull-out design for easy maintenance. Special hydraulics with low NPSHr value.

Capacities 1,100 m³/h / 4,760 USgpm

Heads 230 m / 750 ft

Pressures 25 bar / 360 psi

Temperatures 180 °C / 355 °F

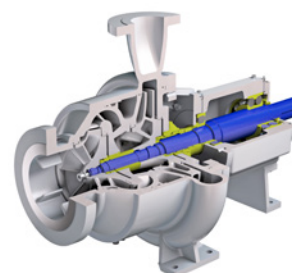



Rely on the Pioneers in Medium Consistency (MC[®]) Technology

Sulzer's MCE™ pumping systems for medium consistency (MC[®]) stock have proven to be the most reliable solution in the pulp and paper industry. Sulzer utilizes application-related Fluider™ technology when selecting pumping solutions for pulp and paper mills. This technology has already been adapted for advanced generation biofuels' feedstock treatment applications.

The Fluider™ technology include proven patented stock pumping ranges:

MCE™ Pumping Systems

LCE™ Pumping Systems

KCE™ Pumping Systems

Advantages and Benefits

- Highest efficiency, reducing power consumption and installation costs
- Correct fluidization prevents fiber over-treatment
- Degassing alternatives include a built-in degassing system, a separate external MDS degassing system, and degassing without a vacuum pump
- High-temperature pumping
- Low and high inlet level pumping
- One-drive unit system in most applications
- Proven long-life mechanical design

Capabilities

- up to 240 m / 790 ft
- from 20 to 5,000 ADMT/d
- consistency range 6 - 18%
- pressure up to 40 bar / 580 psi

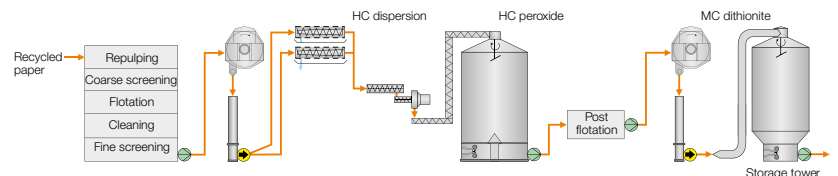

Recycled fiber line

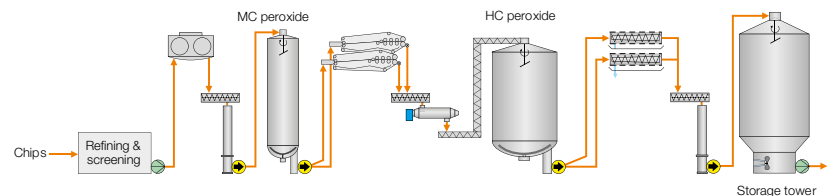

Mechanical pulp line

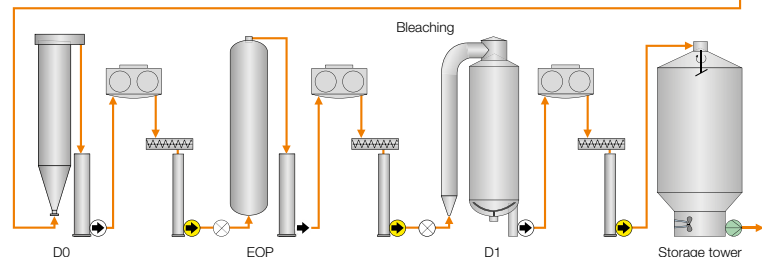
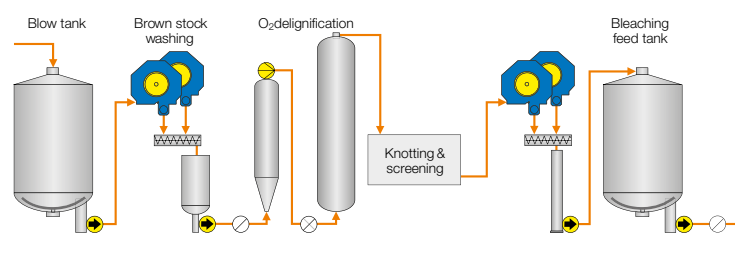

Kraft pulp bleaching line

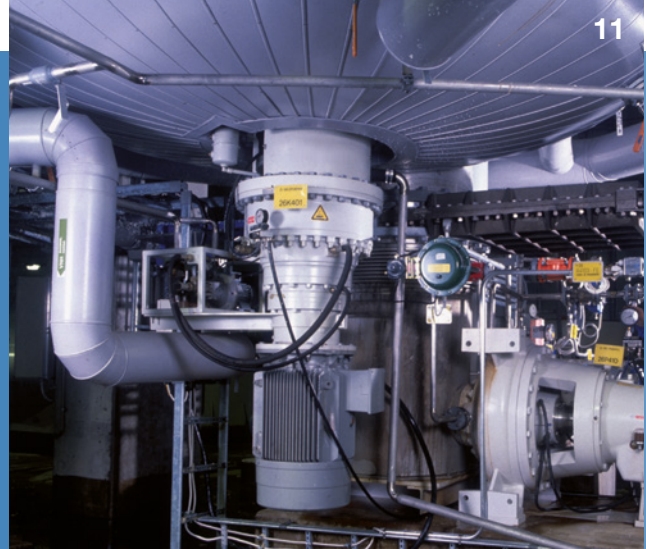

MCE™ Pumping System

The most advanced patented MC® pumping technology for all pulp and paper mill applications and for various other feedstock treatment applications.



LCE™ Pumping System

The most efficient pumping technology for recycled fiber and mechanical pulp line applications and for other semi-MC™ range applications.



KCE™ Pumping System

The most efficient pumping technology when feeding press washers in the Semi-MC™ (intermediate consistency) range and high volume flows.



MC® Discharge Scraper and the Tower Discharge Pumping

To be used for discharging high consistency towers. Capability to 13% tower consistency without dilution, and to 20 - 35% tower consistency with dilution. Outlet consistency typically 8 - 13%.

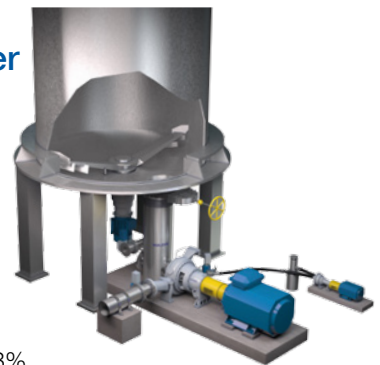

SX Chemical Mixer

Chemical mixer for mixing both gaseous and liquid bleaching chemicals as well as steam into stock.

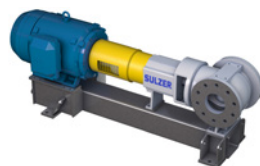

MC® Discharger

MC® Discharger for dividing and controlling high-consistency stock flow and for discharging towers or reactors. It is possible to remove gas from the process with an MC® Discharger.

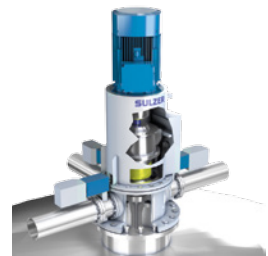



Sulzer's Tower Management System (TMS)

Sulzer has a unique knowledge of the pulp and paper industry's agitation processes and requirements. With more than 30 years experience in PPI, we can help you succeed in today's most challenging mixing tasks for related biofuels applications.



SALOMIX® VULCA *)

VULCA is a tower bottom center fillet pillar. While VULCA stands at the tower bottom, filling and pumping stock through VULCA saves pumping energy, boosts bottom zone mixing, and prevents the mixing of air into the stock at low stock levels.



SALOMIX® TES Top Entry Spreader *)

TES spreads stock evenly on the top surface to control the flow in the upper, high-consistency part of the tower. The quality of the discharged stock remains good. This method offers several advantages:

- Creates a uniform continuous downflow, with no stagnant stock zones
- Variable rotating speed always spreads a fresh top layer of stock, regardless of the surface level
- Prevents channeling and air entrainment in the stock



SALOMIX® GLI *)

GLI is a special center fillet located at the bottom of the storage tower. GLI enables trouble-free operation of high-consistency storage and bleaching towers with a large bottom zone using several agitators. GLI ensures effective mixing, and dilution is intensified by baffles:

- GLI with dilution baffles is used to create a well controlled mixing/dilution zone to the tower bottom.
- GLI effectively separates the storage zone and the active mixing and dilution zone of the tower, thus giving a powerful tool to ensure even discharge consistency and good operation of the tower

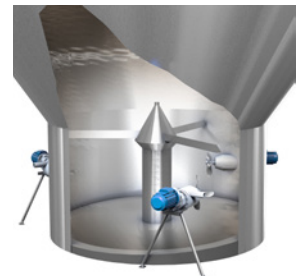



Our Tower Management System for Pulp and Paper Industry to be Adapted for Biofuels

TMS in Chemical Pulp Mills

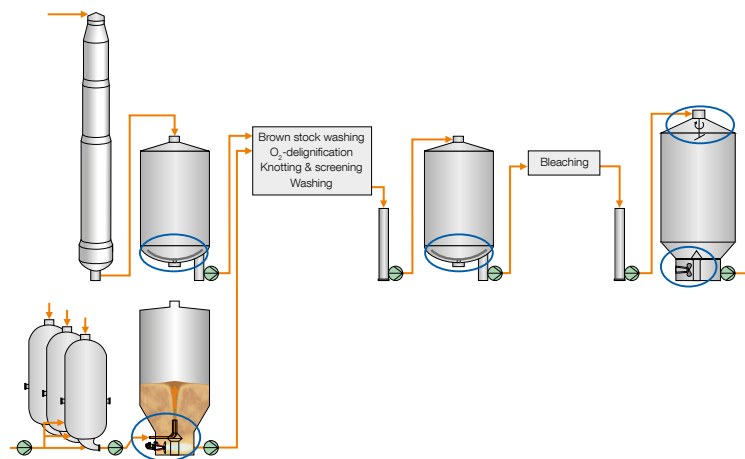

TMS in Mechanical Pulp Mills

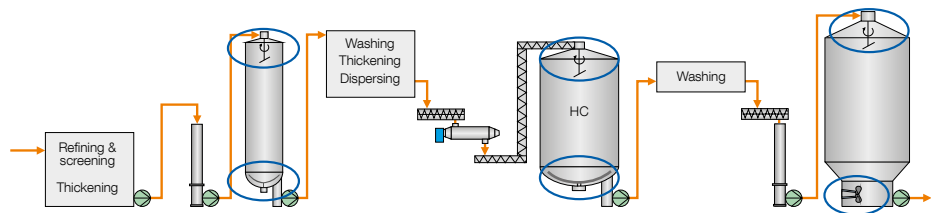

TMS in Recycled Fiber Lines

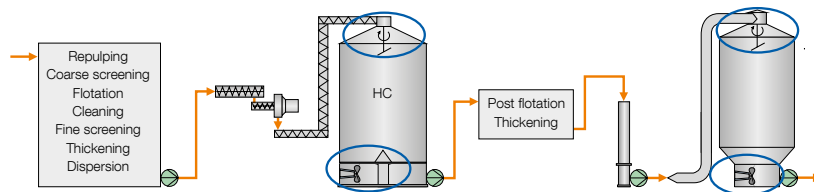

TMS in Paper Mills

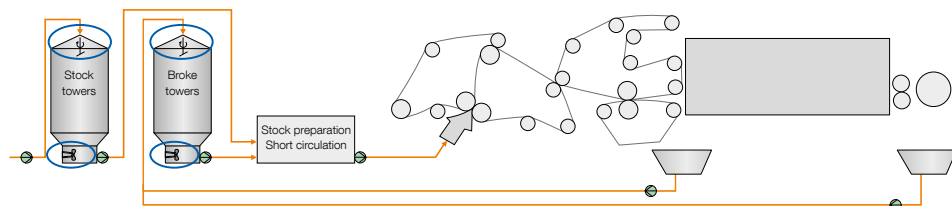



SALOMIX® TES Top Entry Spreader Solving Your Storage Tower Problems

TES spreads stock evenly on the top surface to control the flow in the upper medium- or high-consistency part of the tower. The quality of the discharged stock remains good.

Benefits

- Creates a uniform continuous downflow, with no stagnant zones
- Variable rotating speed always spreads a fresh top layer of stock, regardless of the surface level
- Prevents channelling and air entrainment into the stock

Customer case: TES Solves Retention Time Problem

A customer's 2,000 m³ / 70,600 ft³ storage tower, with an upper diameter of 12 m / 39 ft and a bottom diameter 6.5 m / 21 ft, was operating at less than half its theoretical retention time or four hours for a full stock level.

Test run results show how TES corrected the tower operations to achieve the correct retention time:

Tower level	89%	59%
Measured average retention time	4 h 10 min	2 h 10 min
Theoretical retention time	4 h 24 min	2 h 16 min

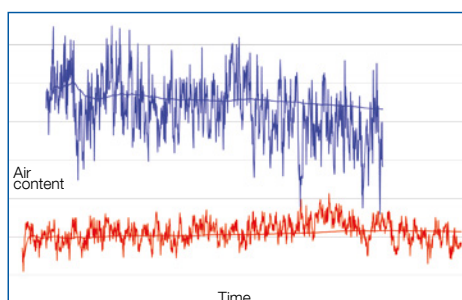

Customer case: TES Solves Entrained Air Problem

The air content of pulp in the customer's storage tower was fluctuating badly and averaging 6% (blue curve in the figure). After installing the TES, the air content decreased to 2% and the variation was markedly reduced, as shown by the red curve.



SALOMIX® Mixing Technology Products for a More Reliable and Efficient Process

SALOMIX® L Series

The L series covers gear or belt driven agitators mounted vertically on the tank top or bottom flange. L series agitators are intended for storage towers, dissolvers, reactors, and production vessels.

- Versatile impeller options meet any process needs in compliance with the rheology of the mixed fluid
- Maximum modular component flexibility
- Applicable for tanks from 1 to 2,500 m³ / 88,285 ft³
- Impeller diameters up to 8,000 mm / 316 in and power range up to 450 kW / 600 hp

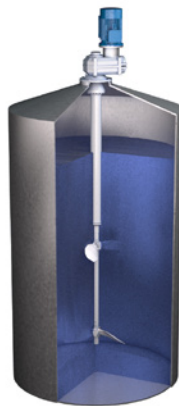

SALOMIX® LV Agitator

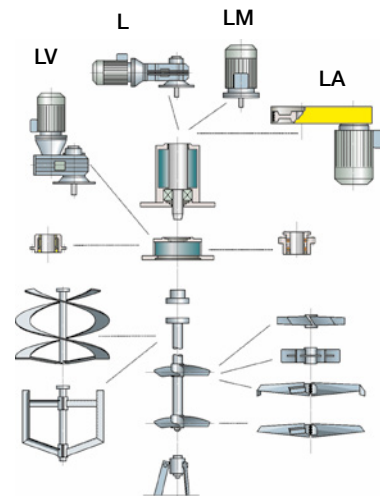

Vertical Module Agitators

SALOMIX® SL/ST

SL/ST sidemounted gear or belt driven propeller agitators are specially designed for all stock process conditions:

- High efficiency results in energy savings and improved agitation
- Cast, four-bladed, adjustable propeller blades give accurate power control
- Conical body shape supports the propeller and ensures vibration free operation
- Maximum agitated consistency up to 6%, power up to 90 kW / 120 hp and propeller diameter up to 1,700 mm / 65 in
- Unique solutions

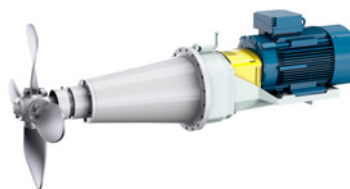

SALOMIX® SLG/SLT
Gear Drive



SALOMIX® SLF/STF
Gear Drive

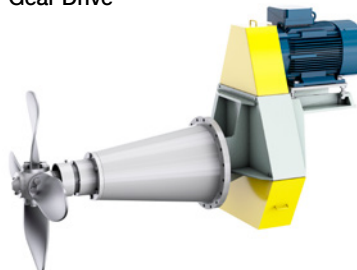

SALOMIX® SLB /SLH,
STB/STH Belt Drive



SALOMIX® SLR/STR

www.sulzer.com

E10076 en 5.2016 (1,000), Copyright © Sulzer Ltd 2016

This brochure is a general product presentation. It does not provide a warranty or guarantee of any kind. Please, contact us for a description of the warranties and guarantees offered with our products. Directions for use and safety will be given separately. All information herein is subject to change without notice.